

Dimensions mm[inch]
 tolerances acc. to DIN ISO 2768-m
 Toleranzen gem. DIN ISO 2768-m

Isometric
 Scale 2:1
 Maßstab 2:1

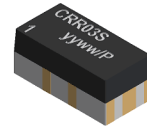

Post reflow height

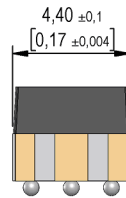
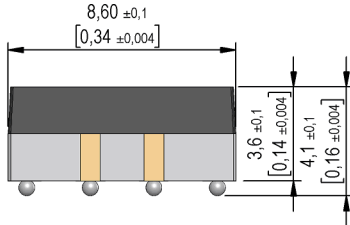
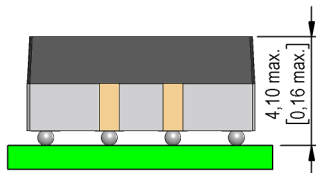

Layout

Top view
 Draufsicht

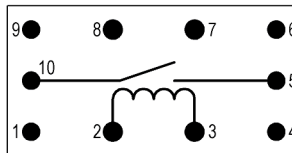

Marking

according to EN60062/factory code
 gem. EN60062/Fertigungsstätte



Recommended PCB Pad Layout

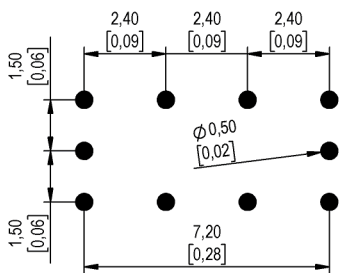

Recommended Reflow Lead-free Profile

(acc. to JEDEC J-STD 020D.1)
 for usage with a tin Sn96.5/Ag3/Cu0.5

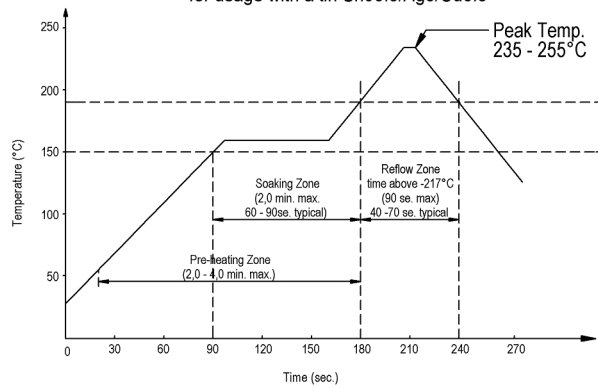

Relay packaging orientation

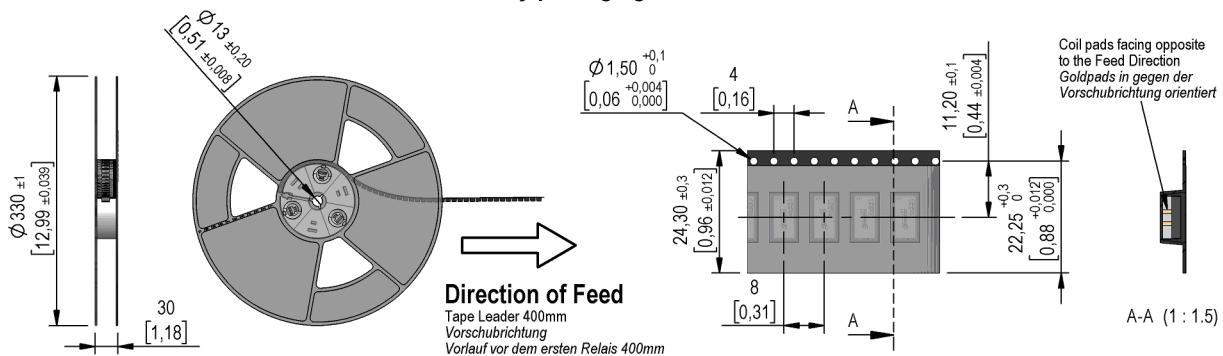



Europe: +49 / 7731 8399 0 | Email: info@standexmeder.com
 USA: +1 / 508 295 0771 | Email: salesusa@standexmeder.com
 Asia: +852 / 2955 1682 | Email: salesasia@standexmeder.com

Item No.:
9603181010
 Item:
CRR03-1AS (250)
CRR03-1AS 250pcs reel

Coil Data at 20 °C	Conditions	Min	Typ	Max	Unit
Coil resistance		63	70	77	Ohm
Coil voltage			3		VDC
Rated power			129		mW
Pull-In voltage				2,25	VDC
Drop-Out voltage		0,45			VDC

Contact data 80	Conditions	Min	Typ	Max	Unit
Contact-material		Rhodium			
Contact-rating	Any DC combination of V & A not to exceed their individual max.'s			10	W
Switching voltage	DC or Peak AC			170	V
Switching current	DC or Peak AC			0,5	A
Carry current	DC or Peak AC			1	A
Contact resistance static	Measured with 40% overdrive Start Value			200	mOhm
Insulation resistance	RH <45 %, 100 V test voltage	100	1.000		GOhm
Breakdown voltage	according to EN 60255-5	210			VDC
Operate time incl. bounce	measured with 40% overdrive			0,6	ms
Release time	measured with no coil excitation			0,05	ms
Capacitance	@ 10 kHz above open switch		0,3	0,5	pF

Special Product Data	Conditions	Min	Typ	Max	Unit
Number of contacts		1			
Contact - form		A - NO			
Contact Bulk Resistance	Through all plated material on substrate		260	440	mOhm
Dielectric Strength Coil/Contact	according to EN 60255-5	1,5			kV DC
Insulation resistance Coil/Contact	RH <45%, 200 VDC Measuring Voltage	10	100		TOhm
Capacitance Coil/Contact	@ 10 kHz		0,9	1,1	pF
Case color		black/white			
Housing material		Ceramic + mineral filled epoxy			
Material connection pads		BGA solderballs D=0,025" (Sn96,5 Ag3 Cu0,5)			
Magnetic Shield		yes, internal			
Approval		UL-File No. NRNT2.E156887			
Reach / RoHS conformity		yes			

Environmental data	Conditions	Min	Typ	Max	Unit
Shock	1/2 sine, duration 11ms, in 3 axis			50	g
Vibration	from 10 - 2000 Hz			20	g
Operating temperature		-40		125	°C
Storage temperature		-55		125	°C
Soldering Temperature Tsold	Reflow acc.IPC/JEDEC J-STD-020D.1			255	°C
Washability		fully sealed			

General data	Conditions	Min	Typ	Max	Unit
Total weight			0,37		g
Packaging		Tape & Reel / 250 pcs.			

Modifications in the sense of technical progress are reserved

Designed at: 22.07.13 Designed by: WKOVACS
 Last Change at: 25.09.17 Last Change by: WKOVACS

Approval at: 30.08.13 Approval by: BLAUBIS
 Approval at: 26.10.17 Approval by: DSTASTNY

Version: 03