

**Dimensions mm[inch]**  
tolerances acc. to DIN ISO 2768-m  
Toleranzen gem. DIN ISO 2768-m

**Isometric**  
Scale 1:2  
Maßstab 1:2

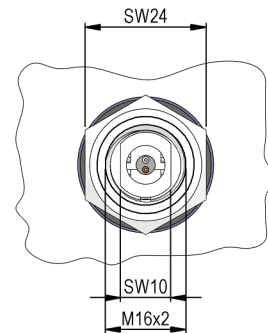
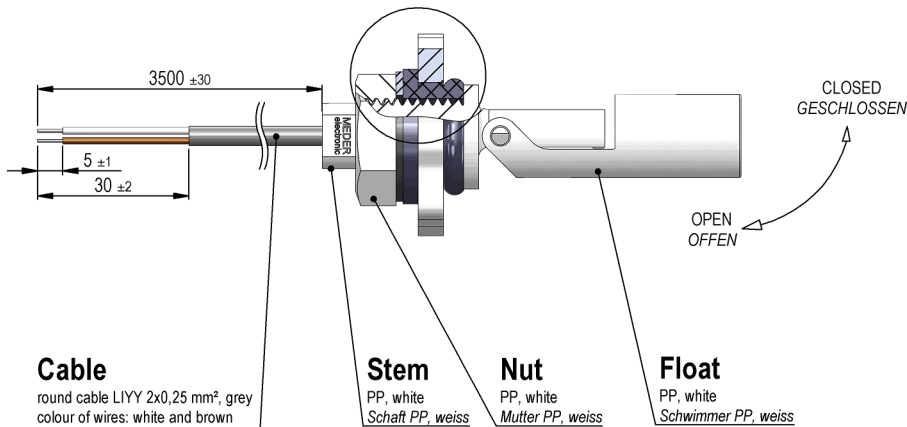
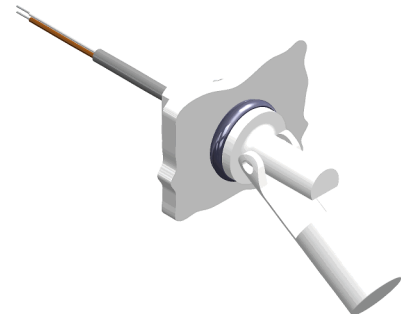
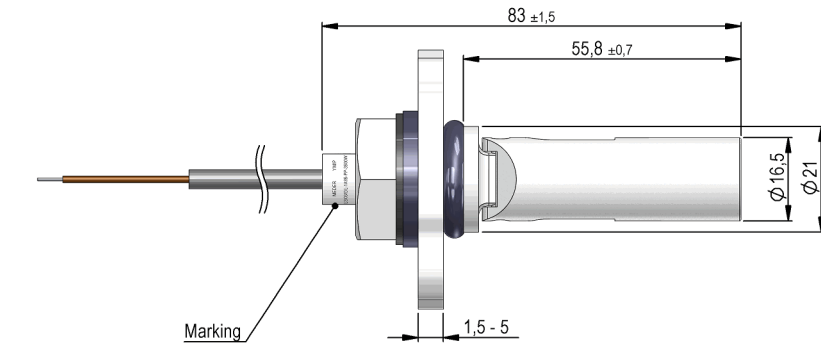

**Cable**

round cable LIYY 2x0,25 mm<sup>2</sup>, grey  
colour of wires: white and brown  
ends tinned  
Rundkabel LIYY 2x0,25 mm<sup>2</sup>, grau  
Aderfarben: weiss und braun  
Enden verzinkt

**Stem**

PP, white  
Schaft PP, weiss

**Nut**

PP, white  
Mutter PP, weiss

**Float**

PP, white  
Schwimmer PP, weiss

**Marking**

according to EN60062/factory code  
gem. EN60062/Fertigungsstätte

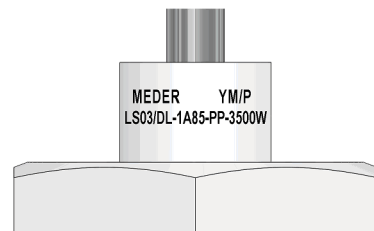

Wall of reservoir  
thickness 1,5 - 5 mm  
mounting hole max. Ø 22 mm  
Wandstärke 1,5 - 5 mm  
Montagebohrung max. Ø 22 mm

plastic slice  
Kunststoffscheibe  
26x17,5x1,45 mm

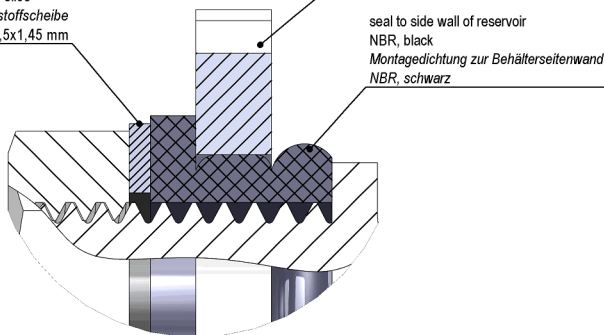

DETAILA (2 : 1)

**Schematic**

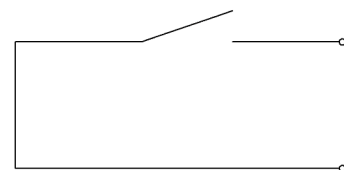



Europe: +49 / 7731 8399 0

| Email: info@standexmeder.com

USA: +1 / 508 295 0771

| Email: salesusa@standexmeder.com

Asia: +852 / 2955 1682

| Email: salesasia@standexmeder.com

Item No.:

**9534285354**

Item:

**LS03/DL-1A85-PP-3500W**

Special Product Data	Conditions	Min	Typ	Max	Unit
Contact rating	Any DC combination of V & A not to exceed their individual max.'s			100	W
Switching voltage	DC or Peak AC			350	V
Carry current	DC or Peak AC			2,5	A
Switching current	DC or Peak AC			1	A
Sensor-resistance	measured with 40% overdrive			720	mOhm
Housing material				PP	
Case colour				white	
Sealing compound				Polyurethan	

Environmental data	Conditions	Min	Typ	Max	Unit
Operating temperature	cable not moved	-30		80	°C
Operating temperature	cable moved	-5		80	°C
Storage temperature		-30		80	°C
Safety class	DIN EN 60529			IP68	

Cable specification	Conditions	Min	Typ	Max	Unit
Cable type				round cable	
Cable material				PVC	
Cross section				0,25 sq-mm	

General data	Conditions	Min	Typ	Max	Unit
Mounting advice				over 5m cable, a resistor is recommended.	

Modifications in the sense of technical progress are reserved

Designed at: 26.05.11    Designed by: WKOVACS

Approval at: 26.05.11    Approval by: DKUECHLER

Last Change at: 13.09.17    Last Change by: WKOVACS

Approval at: 02.11.17    Approval by: DKUECHLER

Rev. No.: 03