

Dimensions mm[inch]
 tolerances acc. to DIN ISO 2768-m
 Toleranzen gem. DIN ISO 2768-m

Isometric
 Scale 1:2
 Maßstab 1:2

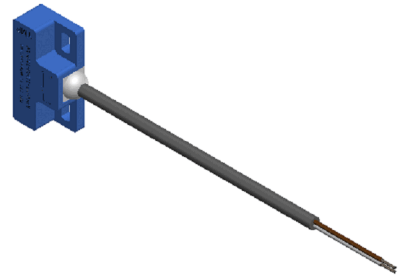
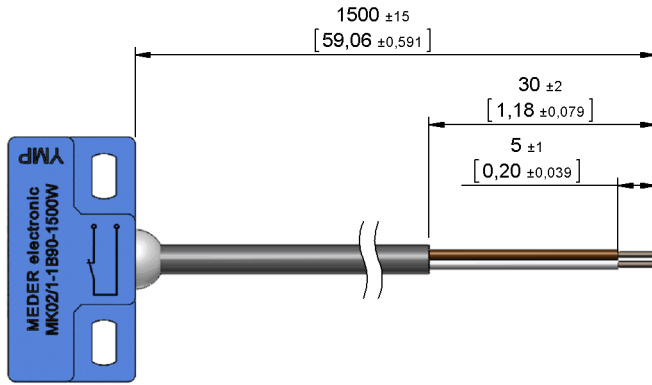

Cable

PVC LIYY 2x0,25qmm
 colour of mantle: grey
 colour of wires: white, brown
 PVC LIYY 2x0,25qmm
 Mantelfarbe: grau
 Aderfarben: weiß, braun

Terminals/Connector

Ends tinned
 Enden verzinkt

Schematic

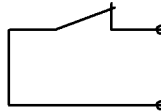

Marking

according to EN60062/factory code
 gem. EN60062/Fertigungsstätte

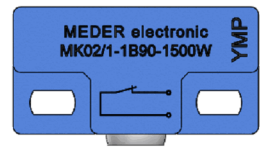

Housing

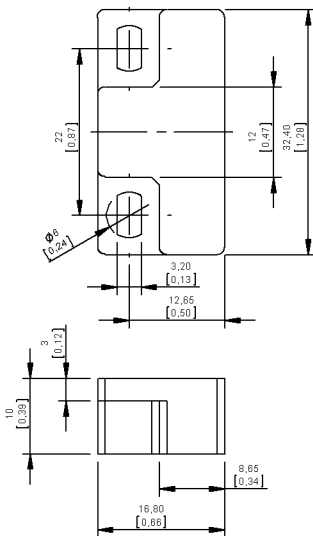

Switching distances

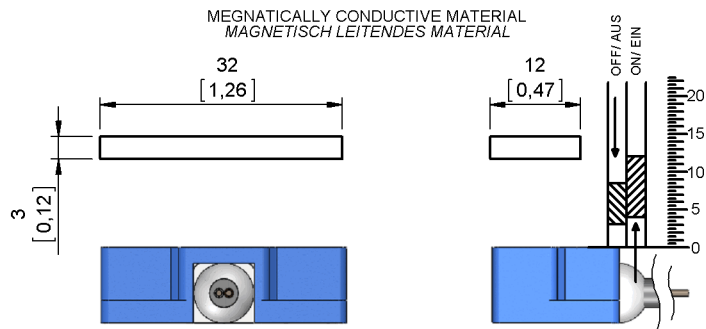



Europe: +49 / 7731 8399 0 | Email: info@meder.com
 USA: +1 / 508 295 0771 | Email: salesusa@meder.com
 Asia: +852 / 2955 1682 | Email: salesasia@meder.com

Item No.:
2221902154
 Item:
MK02/1-1B90-1500W

Products for tomorrow...

Magnetic properties	Conditions	Min	Typ	Max	Unit
Pull in	at 20°C	3		8,5	mm
Drop out	at 20°C	4		12	mm
Test equipment				SV 002	

Special Product Data	Conditions	Min	Typ	Max	Unit
Contact - form				B/C - NC	
Contact - No.				90	
Contact rating	Any DC combination of V & A not to exceed their individual max.'s			10	W
operating voltage	DC or Peak AC			175	V
operating ampere	DC or Peak AC			1	A
Switching current	DC or Peak AC			0,5	A
Sensor-resistance	measured with 40% overdrive Sensor deactivated			400	mOhm
Housing material				PBT glass fibre reinforced	
Case color				blue	
Sealing compound				Polyurethan	

Environmental data	Conditions	Min	Typ	Max	Unit
Operating temperature	cable not moved	-30		80	°C
Operating temperature	cable moved	-5		80	°C
Storage temperature		-30		80	°C

Cable specification	Conditions	Min	Typ	Max	Unit
Cable typ				round cable	
Cable material				PVC	
Cross section				0,25 qmm	

General data	Conditions	Min	Typ	Max	Unit
Mounting advice				over 5m cable, a series resistor is recommended.	
Mounting advice				The mounting of MK02/1 on iron is not allowed.	
Mounting advice				Don't use magnetically conductive screws	
tightening torque	Screw M3 ISO 1207 Disk ISO 7089			0,5	Nm

Modifications in the sense of technical progress are reserved

Designed at: 09.01.08 Designed by: ALICHTENSTEIN
 Last Change at: 15.11.12 Last Change by: OMUELLER

Approval at: 23.04.08 Approval by: BUELTZHOEFFER
 Approval at: 16.11.12 Approval by: TFRITSCHI

Version: 03